



SCHEMA TECNICA

Pedimat



Zerbino arrotolabile

DESCRIZIONE

Zerbino arrotolabile, rimovibile, composto da profili in alluminio estruso, disposti in parallelo e collegati tra loro da cerniere in vinile piene o perforate.

Zerbino fabbricato su misura, adattabile a tutte le forme e dimensioni tramite un giunto riempitivo in vinile (vedere sezione).

Peso: 12 kg/m²

MESSA IN OPERA

Prevedere una fossa di almeno 13 mm per fissare il telaio. Una volta installati il telaio ed eventuali "T" di separazione (per gli zerbini di grandi dimensioni), posare una malta autolivellante su 2 mm di spessore. Per gli zerbini realizzati in diversi pezzi, fissare al suolo eventuali spessori di posizionamento per garantire l'allineamento delle doghe e la buona complanarità dello zerbino.

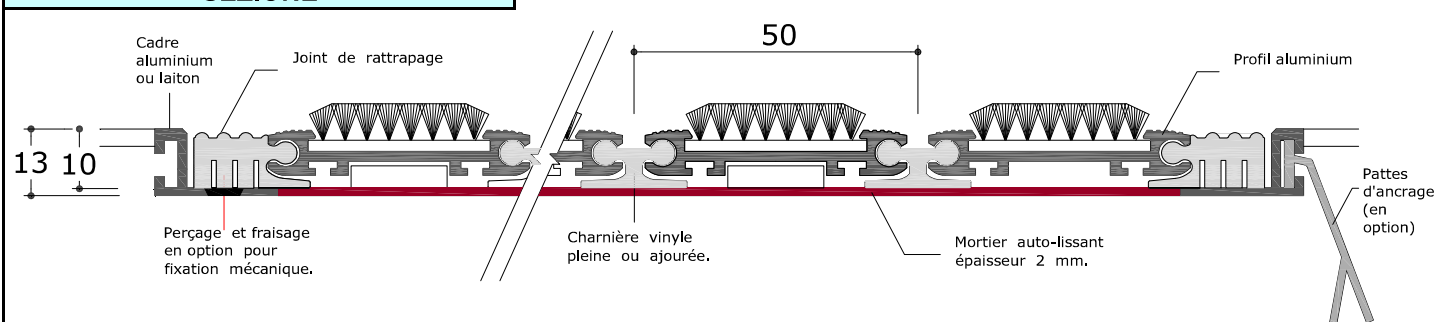

SEZIONE

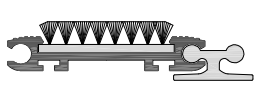
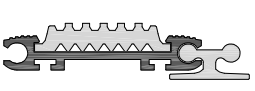
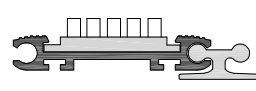
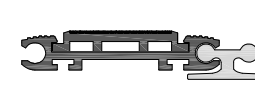

FINITURE

Interno	Interno- Esterno		
Moquette	Vinile	Spazzole	Abrasivo
			
15	13	15	12

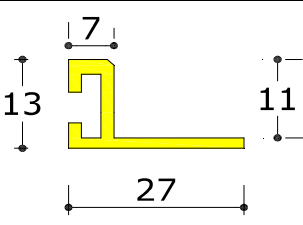
ACCESSORI

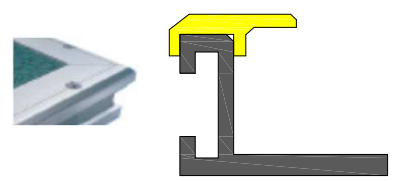
Telaio	Accessori telaio	Bloccaggi di copertura
	  <p>KIT DI ASSEMBLAGGIO E FISSAGGIO PER I TELAI</p>	

Rampa Alluminio	"T" di separazione	Spessori di posizionamento
